

PROJECT	
TYPE	
SPECIFIER	
QUANTITY	
DATE	

PI2 STANDARD SURFACE

A32332-

base number	LED Dimming	Color Temperature	Finishes	Diffuser Options
-------------	-------------	-------------------	----------	------------------

- To build a product code in our configurator select the specify button on the base model # product page
- To build a manual product code on this datasheet choose from the options listed below in blue font and add the suffix to the base model #

GENERAL

Series: Pi2
Subseries: Pi2 Standard
Brand: Prolicht
Division: Architectural
Mounting Type: Surface
Mounting Location: Ceiling
Subcategory: Ambient

PHYSICAL

Shape: Square
Length (mm): 370
Length (in): 14 9/16
Width (mm): 60
Width (in): 2 3/8
Height (mm): 370
Depth (mm): 60
Height (in): 14 9/16
Depth (in): 2 3/8
Light Distribution: Direct
Weight (kg): 3.41
Weight (lbs): 7.50
Diffuser: PMMA - Opal or Micro-Prism
Fixture Finish: SSR / BKV / CWI / CRY / HAB / UFT / ITA / RUA / FTG / MYG / LOD / PUS / FRO / FUP / KIA / POP / BLS / SPG / MEY / GOH / GUM / CHC / COM / ABZ / JAG / OBR / MOS / ROR

ELECTRICAL

Lamp Type: LED (Zhaga Standard)
Input Wattage (W): 13.2
Total Output Wattage (W): 12
Dimming: Tri-Mode (Non-Dimming and Phase Dimming (120Vac only) and 0-10V Dimming)
Driver Included: Yes
Driver Location: Integrated
Driver Type: Constant Current - Universal
Driver Class: Class 2
Input Voltage (V): 120 - 277
Constant Current (MA): 350

LED

Color Temperature (°K): 3000 / 3500 / 4000
Max. Delivered Lumen (lm): 1140 / 1156 / 1180
CRI: >80 CRI
Efficiency (%): 65
Lamp Life (hrs): 50000

OPTICAL

RATINGS AND CERTIFICATIONS

Certified By: Certified for North American Standards
IP rating: IP20

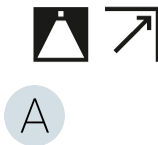
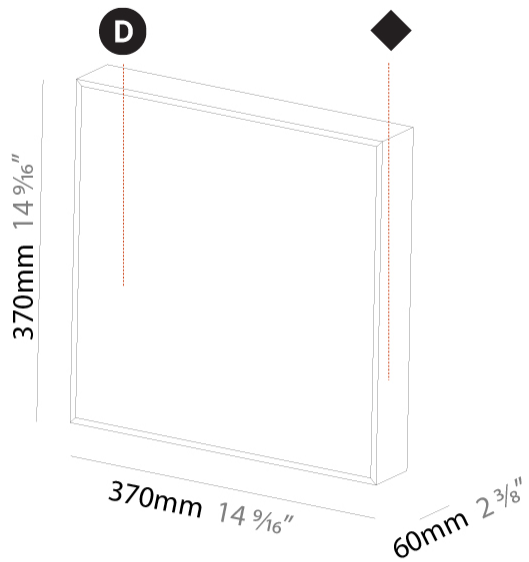

A32332-

PROJECT _____

TYPE _____

SPECIFIER _____

QUANTITY _____

DATE _____

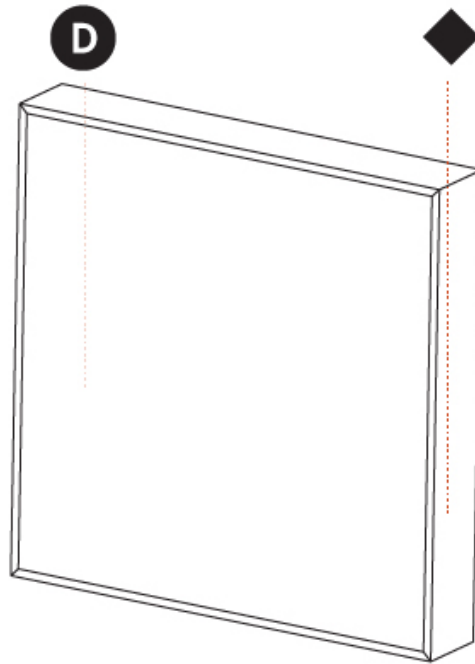

PROJECT	_____
TYPE	_____
SPECIFIER	_____
QUANTITY	_____
DATE	_____

PI2 STANDARD TRIMLESS

A36809- -

base number LED Color
Dimming Temperature

- To build a product code in our configurator select the specify button on the base model # product page
- To build a manual product code on this datasheet choose from the options listed below in blue font and add the suffix to the base model #

GENERAL

Series: Pi2
Subseries: Pi2 Standard
Brand: Prolicht
Division: Architectural
Mounting Type: Trimless
Mounting Location: Ceiling
Subcategory: Ambient

PHYSICAL

Shape: Square
Length (mm): 370
Length (in): 14 9/16
Width (mm): 370
Width (in): 14 9/16
Height (mm): 180
Height (in): 7 1/16
Ceiling Thickness (mm): 10 / 12.5 / 15 / 25 / 30
Ceiling Thickness (in): 3/8 or 1/2 or 9/16 or 1 or 1 3/16
Min. Recessing Depth (mm): 200
Min. Recessing Depth (in): 7 7/8
Light Distribution: Direct
Diffuser: PMMA - Opal
Fixture Finish: SSR / BKV / CWI / CRY / HAB / UFT / ITA / RUA / FTG / MYG / LOD / PUS / FRO / FUP / KIA / POP / BLS / SPG / MEY / GOH / GUM / CHC / COM / ABZ / JAG / OBR / MOS / ROR
Fixture Material: Extruded Aluminum / Steel
Cable Details: 405mm 15 15/16" x 405mm / 15 15/16"
Upon Request: Unique Sizes Unique Ceiling Thickness Unique Mounting Depth Spot Inserts

ELECTRICAL

Lamp Type: LED (Zhaga Standard)
Input Wattage (W): 12.4
Total Output Wattage (W): 10.8
Dimming: Tri-Mode (Non-Dimming and Phase Dimming (120Vac only) and 0-10V Dimming)
Driver Included: Yes
Driver Location: Integrated
Driver Type: Constant Current - Universal
Driver Class: Class 2
Input Voltage (V): 120 - 277
Constant Current (MA): 350

LED

Color Temperature (°K): 3000 / 3500 / 4000
Max. Delivered Lumen (lm): 1090 / 1107 / 1130
CRI: >80 CRI
Efficiency (%): 0.651
Lamp Life (hrs): 50000
Upon Request: RGB-W Tunable White Special Color Temperature CRI90

OPTICAL

RATINGS AND CERTIFICATIONS

Certified By: Certified for North American Standards
IP rating: IP20

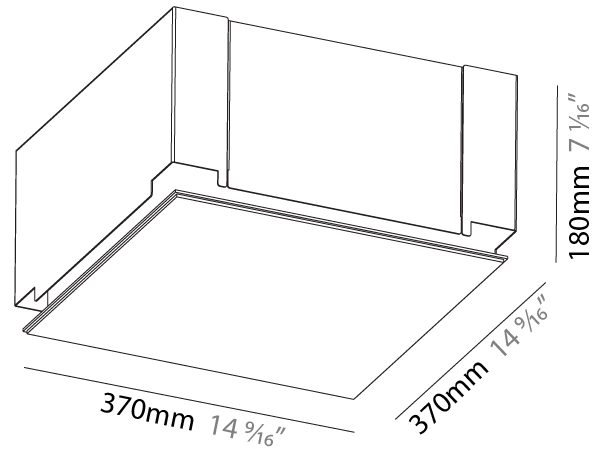

PI2 STANDARD TRIMLESS

A36809-

PROJECT

TYPE

SPECIFIER

QUANTITY

DATE



PROJECT	_____
TYPE	_____
SPECIFIER	_____
QUANTITY	_____
DATE	_____

PI2 WHITELINE TRIMLESS

A37525- _____ - _____

base number LED Color
 Dimming Temperature

- To build a product code in our configurator select the specify button on the base model # product page
- To build a manual product code on this datasheet choose from the options listed below in blue font and add the suffix to the base model #

GENERAL

Series: Pi2
 Subseries: Pi2 Whiteline
 Brand: Prolicht
 Division: Architectural
 Mounting Type: Trimless
 Mounting Location: Ceiling
 Subcategory: Ambient

PHYSICAL

Shape: Rectangle
 Length (mm): 600
 Length (in): 23 5/8
 Width (mm): 195
 Width (in): 7 11/16
 Depth (mm): 165
 Depth (in): 6 1/2
 Ceiling Thickness (mm): 10 / 12.5 / 15 / 25 / 30
 Ceiling Thickness (in): 3/8 or 1/2 or 9/16 or 1 or 1 3/16
 Min. Recessing Depth (mm): 180
 Min. Recessing Depth (in): 7 1/16
 Light Distribution: Direct
 Weight (kg): 4.2
 Weight (lbs): 9.24
 Diffuser: PMMA - Opal
 Fixture Material: Extruded Aluminum / Steel
 Cut-out Measurements: 635mm / 25" x 230mm / 9 1/16"
 Upon Request: Unique Sizes Unique Ceiling Thickness Unique Mounting Depth Spot Inserts

ELECTRICAL

Lamp Type: LED (Zhaga Standard)
 Total Output Wattage (W): 19.1
 Dimming: [Tri-Mode \(Non-Dimming and Phase Dimming \(120Vac only\) and 0-10V Dimming\)](#)
 Driver Included: Yes
 Driver Location: Integrated
 Driver Type: Constant Current - Universal
 Driver Class: Class 2
 Input Voltage (V): 120 - 277
 Constant Current (MA): 500

LED

Color Temperature (°K): [3000](#) / [3500](#) / [4000](#)
 Max. Delivered Lumen (lm): 1430 / 1538 / 1570
 CRI: >80 CRI
 Efficiency (%): 58.2
 Lamp Life (hrs): 50000
 Upon Request: RGB-W Tunable White Special Color Temperature CRI90

OPTICAL

RATINGS AND CERTIFICATIONS

Certified By: Certified for North American Standards
 IP rating: IP20

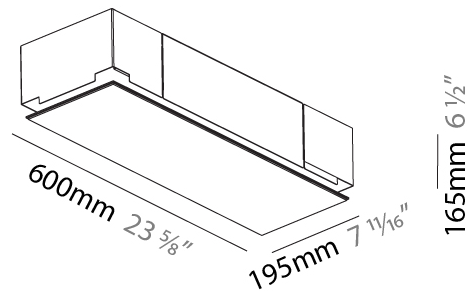

PI2 WHITELINE TRIMLESS

A37525-

PROJECT

TYPE

SPECIFIER

QUANTITY

DATE

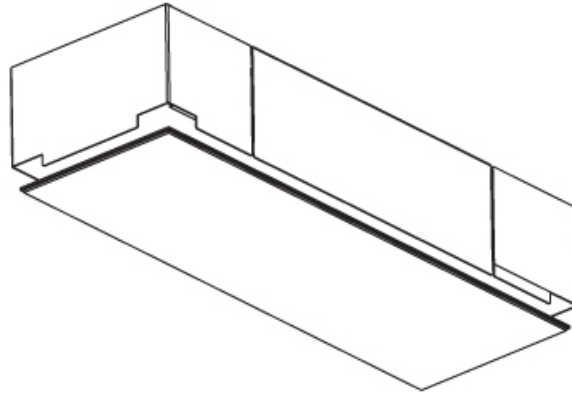

PROJECT
TYPE
SPECIFIER
QUANTITY
DATE

PI2 COLOR FINISH CHART

Fixture Finish



Digital: Not all screens are calibrated the same, and therefore, colors will appear differently between screens.

Physical: When texture is involved, there will be variations in color, character and tone within a product series and between product families.





































































Gun Metal: No Gun Metal finish is alike. It combines a mixture of transparent and black color particles which ensures a highly individual effect and no luminaire being identical.

Champagne Cream, Copper Mine, Ancient Bronze + Jazz Gold: These finishes have slight fading from specific powder coating production. Each luminaire will slightly vary.













PROJECT	
TYPE	
SPECIFIER	
QUANTITY	
DATE	











LEGEND

	floor-mounted		pivotal		special LED (upon request) RGB, RGBW, tunable, gold+, meat+, art+, fashion+
	wall and ceiling: recessed and surface mounted		rotating		warm dim / natural dimming LED
	ceiling-mounted and wall-mounted		illuminate tilted		rechargeable battery powered
	wall-mounted		color of suspension cable		fixture with natural vivid LED (upon request)
	omni-directional light distribution		length of suspension cable		color rendering index
	direct light distribution		reflector degree selection		color temperature
	direct/indirect light distribution		super spot		lumen (luminous flux)
	indirect light distribution		lens		efficacy (lumens per watt)
	asymmetric light distribution		lens pack		Unified Glare Rating (UGR) range from 5-40
	aura light distribution		shine ring		marine grade (AISI 316 stainless steel)
	round wall or ceiling cut-out		integrated shine ring with diffuser		walk on
	square wall or ceiling cut-out		free individual colors 01-29		drive on
	the supplied jig specifies the cutout dimensions		individual colors: 00 (free of charge), 01-25 (extra charge)		Dark Sky Compliance
	minimum distance (meters) lamp - object		luminaire part to be colored (F1)		Americans with Disabilities Act (less than 4" off the wall located between 27"-84" from floor)
	recessed depth		luminaire part to be colored (F2)		lamp protected against explosion
	ceiling thickness in mm		luminaire part to be colored (F3)		blown glass using traditional methods by master glass blower
	ceiling thickness selection		luminaire part to be colored (F4)		acoustic material
	dimmable DP (phase), DV (0-10V), DD (dali), DS (step-dim)		luminaire part to be colored (F5)		protection class I, protection insulation
	included or excluded LED driver/transformer/control gear		color of 3-circuit adaptor		protection class II, protection insulation
	separately switchable		indirect diffuser		ETL Certified to UL and CSA Standards
	sensor		direct diffuser		UL Certified to UL and CSA Standards
	remote control		ball-proof (upon request)		CSA Certified to UL and CSA Standards
	available upon request		accessory		Certified for North American Standards

IP RATING

	protected against ingress of solid bodies greater than 12.5mm (finger)
	protected against ingress of solid bodies greater than 2.5mm protected against sprays of water up to 60 degrees from the vertical (rain)
	protected against ingress of solid bodies greater than 1mm (wire) no protection against the ingress of moisture
	protected against ingress of solid bodies greater than 1mm (wire) protected against sprays of water up to 60 degrees from the vertical (rain)
	protected against ingress of solid bodies greater than 1mm (wire) protected against water splashed from all directions
	protected against limited ingress of dust (wet rooms/covered outdoor areas) protected against water splashed from all directions
	protected against ingress of dust protected against jets of water
	protected against ingress of dust protected against powerful jets of water or heavy seas
	protected against ingress of dust protected against immersion of water between 15cm - 1m for 30 minutes
	protected against ingress of dust protected against immersion of water under pressure for long periods

IK RATING

	protected against 0.14 joules impact (equivalent to 0.25kg mass dropped from 56mm above the surface)
	protected against 0.2 joules impact (equivalent to 0.25kg mass dropped from 80mm above the surface)
	protected against 0.35 joules impact (equivalent to 0.25kg mass dropped from 140mm above the surface)
	protected against 0.5 joules impact (equivalent to 0.25kg mass dropped from 200mm above the surface)
	protected against 0.7 joules impact (equivalent to 0.25kg mass dropped from 280mm above the surface)
	protected against 1 joules impact (equivalent to 0.25kg mass dropped from 400mm above the surface)
	protected against 2 joules impact (equivalent to 0.5kg mass dropped from 400mm above the surface)
	protected against 5 joules impact (equivalent to 1.7kg mass dropped from 300mm above the surface)
	protected against 10 joules impact (equivalent to 5.0kg mass dropped from 200mm above the surface)
	protected against 20 joules impact (equivalent to 5.0kg mass dropped from 400mm above the surface)